

Bohrschema:

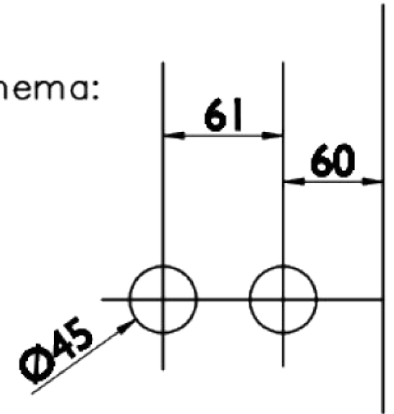

Maßstab: 1:1 ISO2768-m-K

Material:

Benennung: K1 Serie 035-11

	Datum	Name
Bearb.	16.03.2020	
Gepr.		
Norm		

Breuer & Schmitz
GmbH & Co. KG
Solingen - Wald
Baubeschlagfabrik

ZEICHNUNGSNR. K1 Serie 035-11
TEILENUMMER

Blatt
1 (A4)
1 von 1

Ers. für: Ers. durch:

Zust.	Änderung	Datum	Name